

**BALDOR® • RELIANCE®**

---

# Customer information packet

## ECR583004-PPN

M3BN 587MLA 4P B3 300HP

**ABB Oy****PERFORMANCE DATA OF MOTOR**

Department/Author MLA000/TISA	Date of Issue 11.10.2018	Lang. En	Rev. date	Our ref. 3GZFE021035-1234
Customer ref.		Saving Ident TMAA-ASUG9J-TISA28	Rev./Changed by A	Pages 1/3

**Driven Motor:**

Catalog Number Motor type code Motor product code Motor type Mounting designation Protected by enclosure Method of cooling Insulation Service factor Standards International efficiency classification (IEC 60034-30) Ambient temperature, max. Altitude, max.	<b>ECR583004-PPN</b> M3BN 587 MLA 4 3GBN982410-ADKBA01 Squirrel cage Motor IM 1001 IP66 TEFC Class F (Shock Resistant) SF1.15 TEMP RISE CLASS B NEMA IE3 40 °C 3280 ft.a.s.l.
Duty type Temp. rise Connection of stator winding Rated output Voltage Frequency Speed Current	Continuous Class B Delta 300 HP 460 V 60 Hz 1792 r/min 343 Amps
Locked rotor Amps Locked rotor torque Breakdown torque No load current Rated torque	770 % 250 % 310 % 123 Amps 880 lb-ft
Load characteristics	Code H
	Load % 100 75 50
	Current Amps 343 269 202
	Efficiency % 96,2 96,4 95,7
	Power Factor 0,85 0,81 0,72
NEMA nominal efficiency Typical calculated values to NEMA. -	
	96,2 %

Motors & Generators Visiting Address  
Stroinbergin puistotie 5 A  
VAASA  
FINLAND

Postal Address  
P.O.Box 633  
FI-65101 VAASA  
FINLAND

**ABB Oy**

Telephone  
+358 10 222 000

Telefax  
+358 10 224 7372

**PERFORMANCE DATA OF MOTOR**



<b>ABB Oy</b> <b>Motors &amp; Generators</b>		Date of Issue		Lang.	Rev. date	Our ref.	Pages
Department/Author MLA000/TISA		11.10.2018		En		3GZF021035-1234	2/3
Customer ref.		Saving Ident		Rev./Changed by			
		TMAA-ASUG9J-TISA28		A			

Motor type code: M3BN 587 MLA 4

Rated output	300 HP	Power Factor	0,85
Voltage	460 V	Rated torque	880 lb-ft
Frequency	60 Hz	Locked rotor Amps	770 %
Speed	1792 r/min	Locked rotor torque	250 %
Current	343 Amps	Breakdown torque	310 %

**Torque and Current as a Function of Speed**

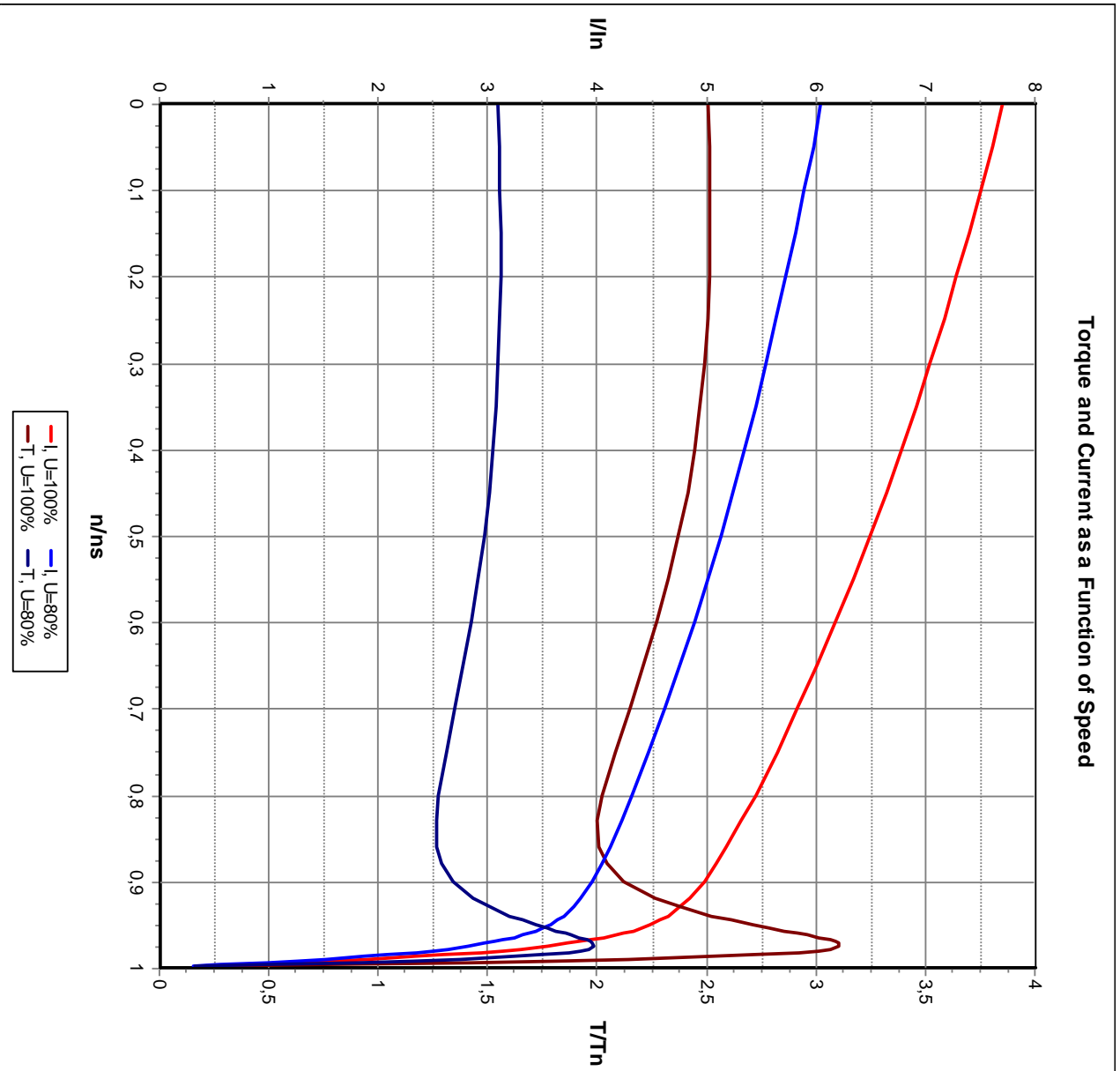

Motors & Generators Visiting Address  
Stroinbergin puistotie 5 A  
VAASA  
FINLAND

ABB Oy  
Postal Address  
P.O.Box 633  
FI-65101 VAASA  
FINLAND

Telephone  
+358 10 222 000

Telefax  
+358 10 224 7372

<b>ABB Oy</b> <b>Motors &amp; Generators</b>		Classifying code or document type		<b>PERFORMANCE DATA OF MOTOR</b>			
Department/Author	MLA000/TISA	Date of Issue	11.10.2018	Lang.	En	Rev. date	
Customer ref.		Saving Ident	TMAA-ASUG9J-TISA28	Our ref.	3GZF021035-1234	Rev./Changed by	A
						Pages	3/3

PWM  
Switch. freq. 3KHz  
FWP 460VD 60Hz

<b>Drive1</b>	
Rated power	75 HP
Rated voltage	117 V
Nominal frequency	15,3 Hz
Type of connection	Delta
Rated torque	876 lb-ft
Speed	450 rpm
Current	345 Amps

<b>Drive2</b>	
Rated power	300 HP
Rated voltage	460 V
Nominal frequency	60,4 Hz
Type of connection	Delta
Rated torque	876 lb-ft
Speed	1800 rpm
Current	377 Amps

Constant torque 450 – 1800rpm



Motors & Generators Visiting Address  
Stroinbergin puistitie 5 A  
VAASA  
FINLAND

Postal Address  
P.O.Box 633  
FI-65101 VAASA  
FINLAND

**ABB Oy**

Telephone  
+358 10 222 000

Telefax  
+358 10 224 7372

<p><b>Connection Diagram</b></p>		<p>Document No: 3GZF321100-1 E</p>	
		<p>Description: 3-PHASE SQUIRREL-CAGE MOTOR</p>	
<p>Unit: Motors</p>	<p>Issued by: M Prusi</p>	<p>Replaces:</p>	
<p>Date: 21.09.2005</p>	<p>Approved by: Jari Raitila</p>	<p>Replaced by:</p>	
<p>ABB Oy</p>		<p>Customer Reference:</p>	

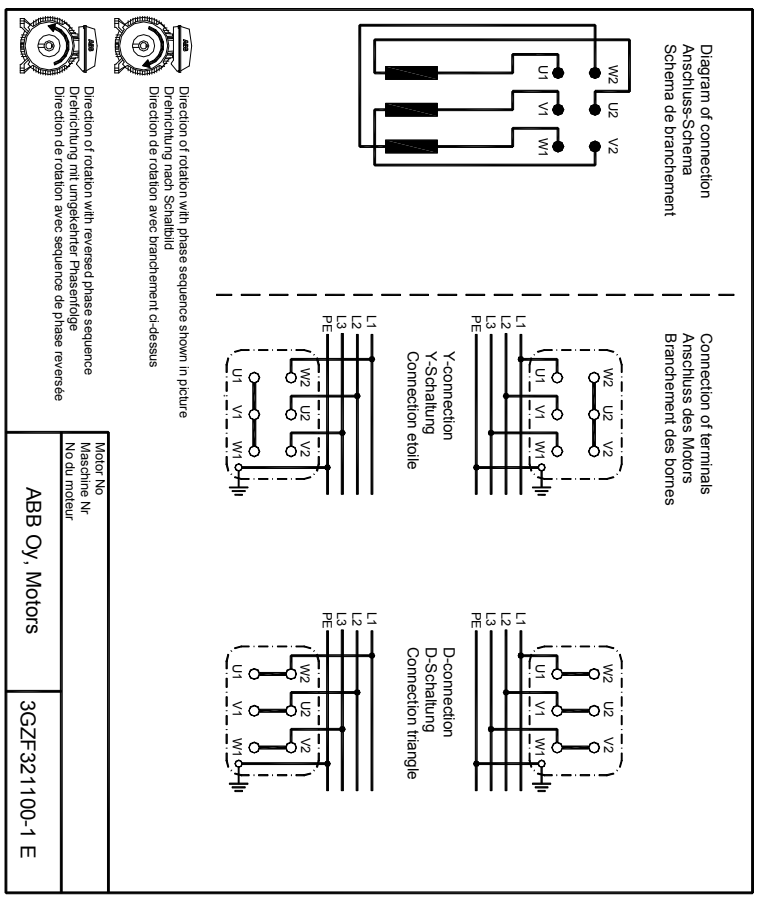

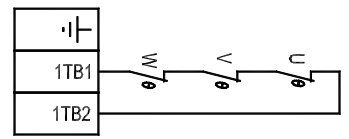
<h2 style="margin: 0;">Accessory Connection Diagram</h2>				Document No: <b>3GZF321200-35 B</b>
Description: <b>BIMETAL DETECTORS</b>				
Unit: <b>Electrical Machines, LV Motors</b>	Issued by: <b>K. Höglkvist</b>	Replaces: Replaced by:		
Date: <b>16.01.2002</b>	Approved by: <b>M. Prusi</b>			
<b>ABB Oy</b>		Customer Reference:		

<p style="margin: 0;"> <b>BIMETAL DETECTORS, TYPE NCC</b>  <b>1TB1...1TB2 BIMETALL-THERMOSCHALTER, TYP NCC</b>  <b>SONDES BIMETALLIQUES, TYPE NCC</b> </p>	
Motor No Maschine Nr Moteur No	<b>ABB Oy, Electrical Machines</b> <b>LV Motors</b>
<b>3GZF321200-35 B</b>	<b>B</b>

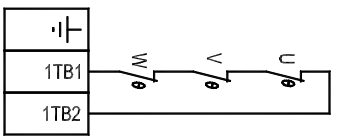
<p><b>Accessory Connection Diagram</b></p>		<p>Document No: 3GZF321200-1 D</p>	
		<p>Description: PTC-THERMISTORS</p>	
<p>Unit: Motors</p>	<p>Issued by: K. Höglkvist</p>	<p>Replaces:</p>	
<p>Date: 30.11.2005</p>	<p>Approved by: M. Prusi</p>	<p>Replaced by:</p>	
<p>Customer Reference:</p>		<p>ABB Oy</p>	

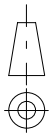
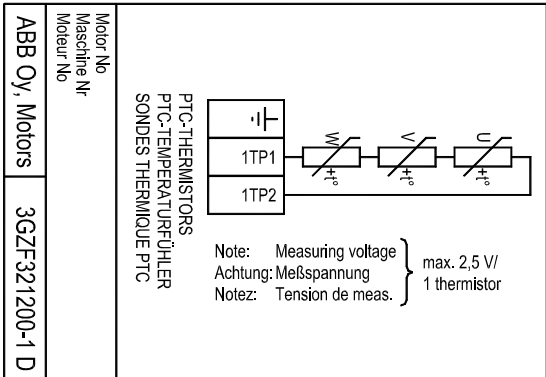

Additional Information:		
<b>Dimension Print</b>		Motor Type: M3BN 587ML_4.. B3, B6, B7, B8, V5, V6
Description: SQUIRREL CAGE MOTOR, CABLE ENTRY LHS, SPECIAL SHAFT, SLOTTED FEET HOLES. DIMENSIONS IN INCHES, MOTOR SIZES 586/587.		Document No: 3GZF500098-174 A 14 BN 587 A
Unit: ABB Oy, Motors and Generators	Issued by: N.Palokangas	Replaces:
Date: 21.11.2019	Approved by: S.Tikkanen	Replaced by:
Customer Reference:		ABB

